

WTX

Complete Stainless Steel Monoblock Process Pumps



FEATURES

- WTX, stainless steel, horizontal shaft, non-self-priming, single stage centrifugal volute pumps are made by advanced techniques such as pressing welding of corrosion resistant plate.
- Axial suction part and radial discharge part
- Inlet and outlet flanges are PN10
- Standard DIN flange connection.
- Discharge parts DN32 to DN50
- The pumps are of the back pull out design enabling removal of the motor coupling, bearing bracket and impeller without disturbing the pump housing or pipe work.
- Close-coupled centrifugal pumps, electric motor with extended shaft directly connected to the pump.
- Extended Shaft: Close-coupled by means of an adaptor bracket with an impeller keyed directly to the special motor shaft extension.
Stub Shaft: Rigid-coupled with a bracket, an adaptor and a rigid coupling keyed to the standard motor shaft extension.
- Low noise motor with high-quality mechanical seal
- Temperature of pumped liquid -10 °C to +110 °C
- Ambient temperature up to 40 °C
- Maximum operating pressure 10 Bar
- IP55 protection, insulation class: F
- Variable Speed by optional "WDRIVE" drive

PERFORMANCE CURVE SPECIFICATION

- Tolerances according to ISO9906 Annex A
- The curves based on the measured value of asynchronous motors at 50 Hz under the constant speed of 2900 rpm or 250 rpm.
- Measurements were carried out with clean water at 20°C of temperature and kinematics viscosity $\nu = 1 \text{ mm}^2/\text{s}$ (cst)
- In order to avoid the risk of over-heating, the pumps should not be used at a flow rate below 10% of best efficiency point.

APPLICATION

Water Technologies WTX series is a sort of multi-functional product with wide application. It is suitable for many different applications demanding reliable and efficient products that require constant or variable duty points in cost saving operation.

Commercial Building Services Applications

HVAC

- Liquid transfer in heating and air-conditioning systems
- Liquid transfer in ventilating systems
- Liquid transfer with mildly aggressive liquids or environment

WATER SUPPLY

- Pressure boosting in commercial buildings
- Irrigation systems
- Water transfer for green houses
- Fire-fighting systems

DIVERSE OEM APPLICATIONS

Industry Applications

PROCESS

- Process cooling, process heating and air-conditioning
- Heat recovery systems

WATER SUPPLY

- Pressure boosting
- Irrigation systems
- Water transfer for green houses
- Moving industrial and mildly aggressive liquids or environment

WATER TREATMENT

- Washing and cleaning plants
- Water treatment

EMPTYING

Most Commonly Used Liquids

- Caustic Soda (25%)
- Water Deionized (100%)
- Citric Acid (25%)
- Acetic Acid (80%)
- Cutting Fluid (100%)
- Clean Water (100%)
- Cleaning Products (5%)
- Emulsion Oil and Water (any)
- Ethylene glycol (50%)
- Mineral Oil (100%)
- Sulphuric Acid (2%, 97-98%)
- Vegetable Oil (particle-free) (100%)
- Glycerin (100%)

WTX

Complete Stainless Steel Monoblock Process Pumps

WTX

Pump Model	P2		Flow Rate (Q)																					
			l/min	0	50	100	150	166	200	250	300	333	350	416	500	583	666	750	833	916	1000	1083	1166	
	kW	HP	m³/h	0	3	6	9	10	12	15	18	20	21	25	30	35	40	45	50	55	60	65	70	
WTX 32-160/1,1	1,1	1,5	H (m)	21,5	21	20	18,5	17,7	16,9	15	12,5	10	8,7											
WTX 32-160/1,5	1,5	2		27	26	24,5	22,5	21,3	20,4	18	15	12,5	11											
WTX 32-160/2,2	2,2	3		32	30,5	29,5	27,5	27	26,2	24	22	20	18,7											
WTX 32-200/3	3	4		39	38	37	35,2	34,8	33,8	32	29,3	27,8	27											
WTX 32-200/4	4	5,5		54	51,5	50	48	47	45,4	43	40,7	36,7	36											
WTX 32-200/5,5	5,5	7,5		65	62	60,4	58	57	54,9	51,4	46,8	42	40											
WTX 40-125/1,5	1,5	2		21				18,7	18	17,5	16,5	16	15,5	13,5	10,5									
WTX 40-125/2,2	2,2	3		28				26	25	24	23	22	21,5	20	17	14								
WTX 40-125/3	3	4		31				30	29,2	28,6	27,5	27	26,5	25	22	18								
WTX 40-160/4	4	5,5		40				38	37	36,5	34,9	34	33,5	31	28	24	19							
WTX 40-200/5,5	5,5	7,5		47				46	45,7	45,5	44	43,5	43	41	38	34	30							
WTX 40-200/7,5	7,5	10		52				51,5	51,2	51	49,8	49,5	48,7	47,5	45	42	38							
WTX 40-200/11	11	15		69				69	68,7	68,5	68,2	68	67,7	67	66	64	60							
WTX 50-125/3	3	4		26						23,7	23,3	23	22,5	21,3	20	17,5	16	12,6	10					
WTX 50-125/4	4	5,5		28						26,3	25,6	25,3	24,8	23,7	23	21,3	19,8	17,5	16					
WTX 50-160/5,5	5,5	7,5		35								34	33,9	32,5	31,5	30	28,5	27	24,9					
WTX 50-200/7,5	7,5	10		42								40,5	40,4	40	39	37,5	36	34	32					
WTX 50-200/9,2	9,2	12,5		52								50	49,9	49	48,5	47	45	43	41					
WTX 50-200/11	11	15		58								55	54,8	54,4	53	52	51	48,5	47	35	31			
WTX 50-200/15	15	20		71								67,5	66,9	66,5	65,2	64,8	63,5	62	60	53	50			
WTX 50-200/18,5	18,5	25	73								71	70,8	70,5	70,1	69,9	69	68	67	62	59				

Pump Model	P2		Flow Rate (Q)																					
			l/min	0	666	833	1000	1083	1166	1333	1416	1500	1666	1833	2000	2166	2333	2500	2666	2833	3000	3200	3333	
	kW	HP	m³/h	0	40	50	60	65	70	80	85	90	100	110	120	130	140	150	160	170	180	192	200	
WTX 65-125/4	4	5,5	H (m)	21	19	18	16,8	16	15	13	12	11	9											
WTX 65-125/5,5	5,5	7,5		24	22	21	20,3	19,5	19	18	17	16,1	14,8	12,7	10									
WTX 65-125/7,5	7,5	10		28	27	26	25,5	25	24,3	23	22,2	21,9	20	18	15									
WTX 65-125/9,2	9,2	12,5		31	30	29,4	29	28,4	28,1	27	26,5	26,1	25	23,5	22	19								
WTX 65-160/11	11	15		37	36	35	34	33,4	33	32	31,5	31	29	27	25	22								
WTX 65-160/15	15	20		46	44	43	42	41	40,3	39	38,5	38	37	35,8	33,5	32								
WTX 65-200/18,5	18,5	25		55	53	52	51,4	51	50,3	49	48,5	48	47	45,3	44	41								
WTX 65-200/22	22	30		63	60	59,6	58,2	57,5	57	56,5	55,8	55	54	53	50,5	49								
WTX 65-200/30	30	40		75	73	72	71,5	71	70,1	69,5	69	68	67	66	64	63								
WTX 80-160/11	11	15		27			26	25,5	25	24,5	24	23,5	23	22,5	22	21,4	20	18,5	17	16,6	14,5	11		
WTX 80-160/15	15	20		36			34,9	34,5	33,7	33	32,4	32	31	30,2	29	28,5	27	26	24	22,5	21,3	19	18	
WTX 80-160/18,5	18,5	25		42			39,5	39	38,8	38	37,5	37	36,5	36	35,1	33,7	33	31,2	30	27,5	26,5	23,5	22	
WTX 80-200/22	22	30		49			46	45,5	45	44,5	44	43,5	43	41	40,6	39,5	38	36,5	35	33	31	27	26	
WTX 80-200/30	30	40		61			57,5	57	56,5	56	55,5	55,3	55	53	52	50	49	47,5	46	43	41	37	36	
WTX 80-200/37	37	50		69			66	65,7	65,5	65	64,5	64	63	62,5	61	60	59	57,5	56	53	51,5	48,5	47	

WTX

Complete Stainless Steel Monoblock Process Pumps

WTX 32-160

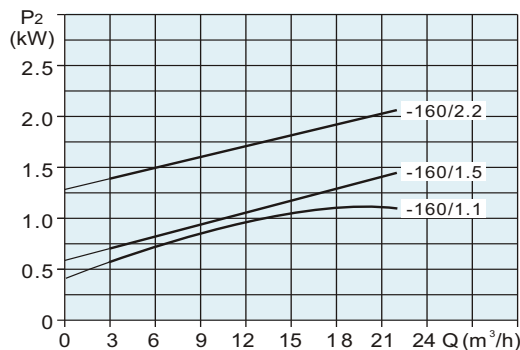
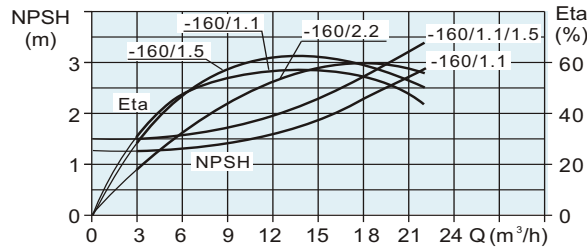
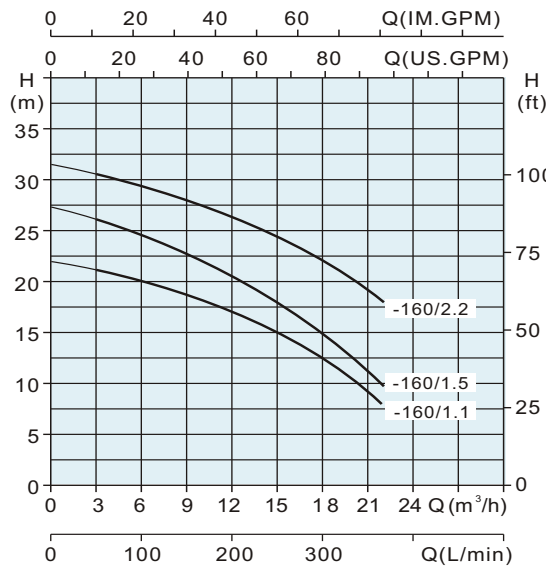

PUMP MODEL	P2		FLOW RATE (Q)												
			l/min	0	50	100	150	166	200	208	250	300	333	350	336
	m³/h	0	3	6	9	10	12	12,5	15	18	20	21	22		
WTX 32-160/1,1	1,1	1,5	H (m)	21,5	21	20	18,5	17,7	16,9	16,5	15	12,5	10	8,7	8
WTX 32-160/1,5	1,5	2		27	26	24,5	22,5	21,3	20,4	20	18	15	12,5	11	9,5
WTX 32-160/2,2	2,2	3		32	30,5	29,5	27,5	27	26,2	26	24	22	20	18,7	18

WTX

Complete Stainless Steel Monoblock Process Pumps

WTX 32-200

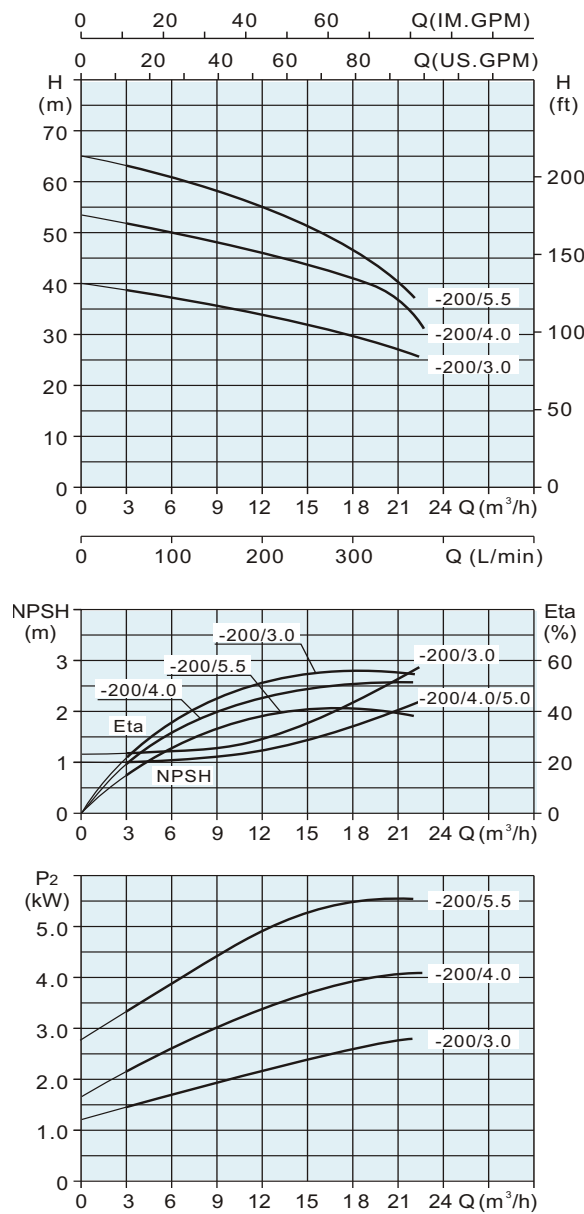

PUMP MODEL	P2		FLOW RATE (Q)												
			l/min	0	50	100	150	166	200	208	250	300	333	350	366
	kW	HP	m³/h	0	3	6	9	10	12	12,5	15	18	20	21	22
WTX 32-200/3	3	4	H (m)	39	38	37	35,2	34,8	33,8	33,5	32	29,3	27,8	27	26
WTX 32-200/4	4	5,5		54	51,5	50	48	47	45,4	45	43	40,7	36,7	36	30
WTX 32-200/5,5	5,5	7,5		65	62	60,4	58	57	54,9	54	51,4	46,8	42	40	37

WTX

Complete Stainless Steel Monoblock Process Pumps

WTX 40-125

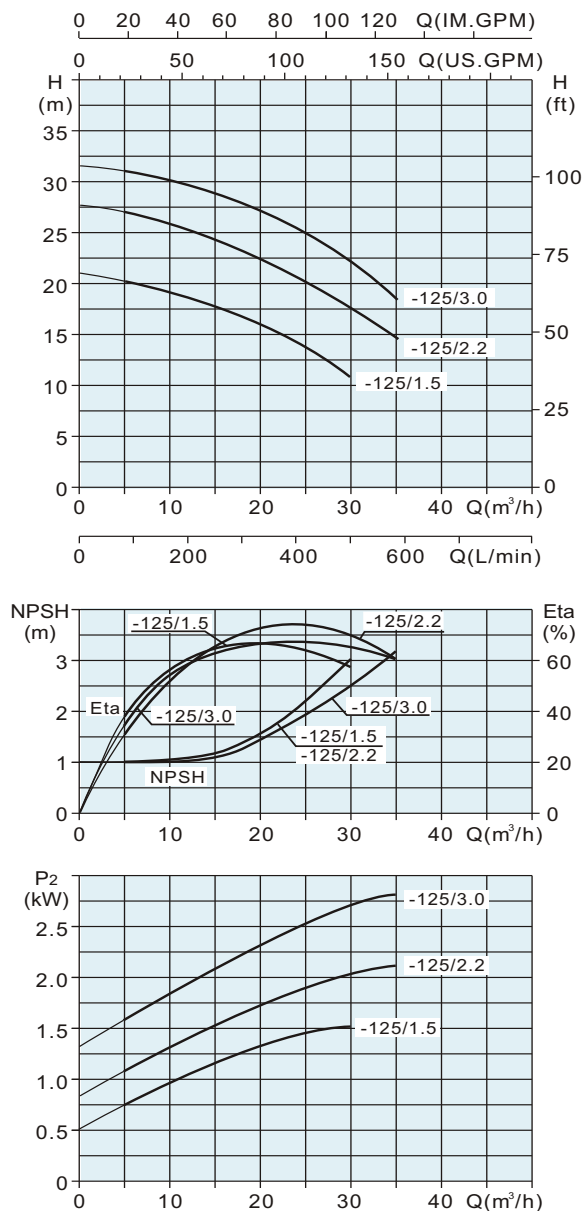

PUMP MODEL	P2		FLOW RATE (Q)											
	kW	HP	l/min m³/h	0	83	166	200	250	300	333	350	416	500	583
WTX 40-125/1,5	1,5	2	H (m)	21	20	18,7	18	17,5	16,5	16	15,5	13,5	10,5	
WTX 40-125/2,2	2,2	3		28	27	26	25	24	23	22	21,5	20	17	14
WTX 40-125/3	3	4		31	31	30	29,2	28,6	27,5	27	26,5	25	22	18

WTX

Complete Stainless Steel Monoblock Process Pumps

WTX 40-160 & 200

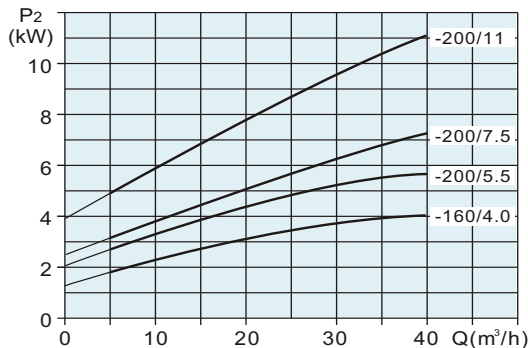
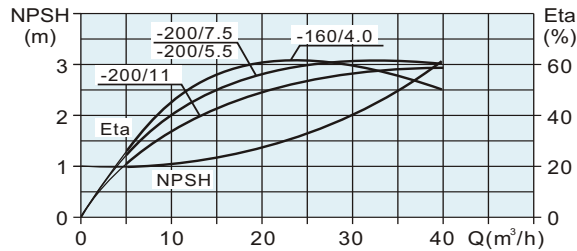
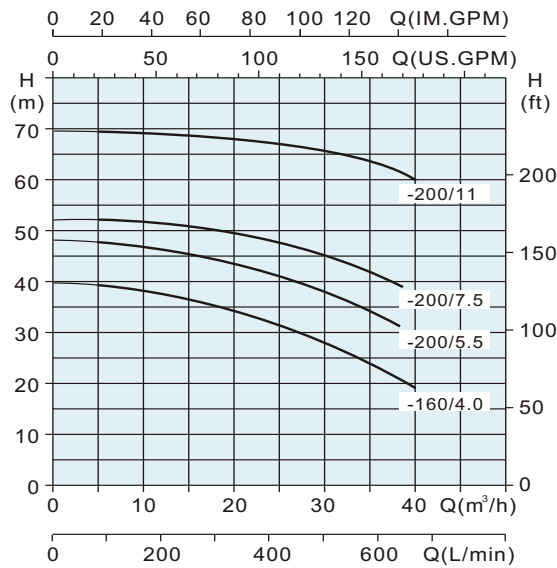

PUMP MODEL	P2		FLOW RATE (Q)												
			l/min	0	83	166	200	250	300	333	350	416	500	583	666
	kW	HP	m³/h	0	5	10	12	15	18	20	21	25	30	35	40
WTX 40-160/4	4	5,5	H (m)	40	39	38	37	36,5	34,9	34	33,5	31	28	24	19
WTX 40-200/5,5	5,5	7,5		47	46	46	45,7	45,5	44	43,5	43	41	38	34	30
WTX 40-200/7,5	7,5	10		52	51	51,5	51,2	51	49,8	49,5	48,7	47,5	45	42	38
WTX 40-200/11	11	15		69	68	69	68,7	68,5	68,2	68	67,7	67	66	64	60

WTX

Complete Stainless Steel Monoblock Process Pumps

WTX 50-125

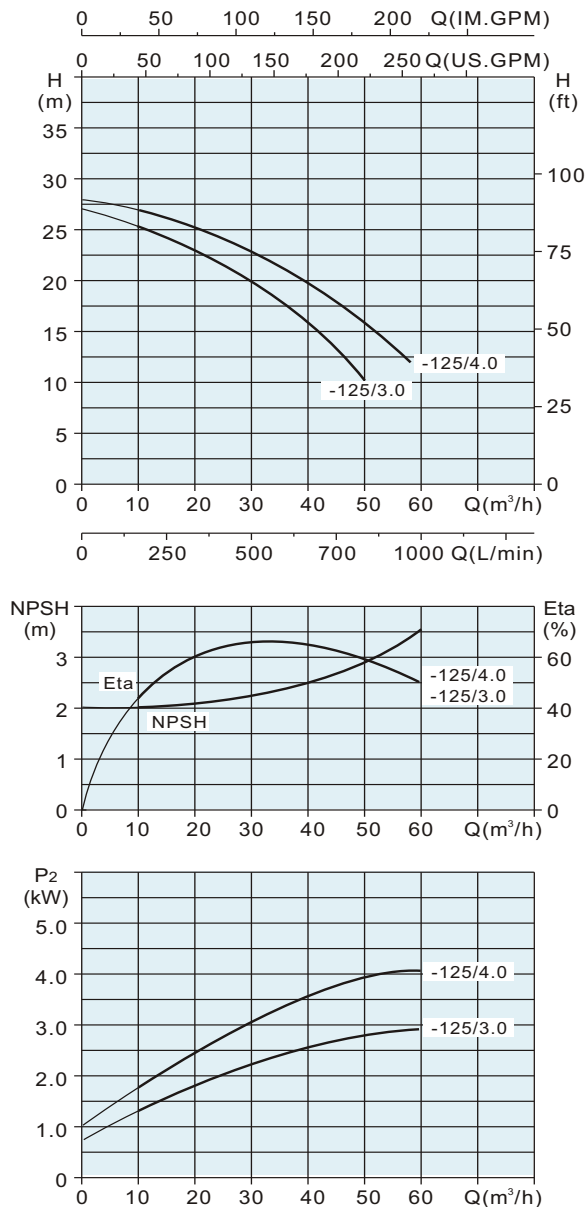

PUMP MODEL	P2		FLOW RATE (Q)												
			l/min m³/h	0	250	300	333	350	416	500	583	666	750	833	
WTX 50-125/3	3	4	H (m)	27	23,7	23,3	23	22,5	21,3	20	17,5	16	12,6	10	
WTX 50-125/4	4	5,5	H (m)	28	26,3	25,6	25,3	24,8	23,7	23	21,3	19,8	17,5	16	

WTX

Complete Stainless Steel Monoblock Process Pumps

WTX 50-160 & 200

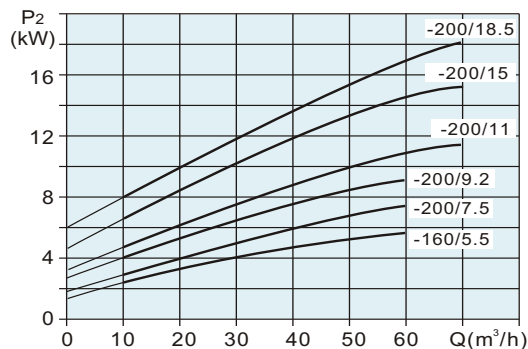
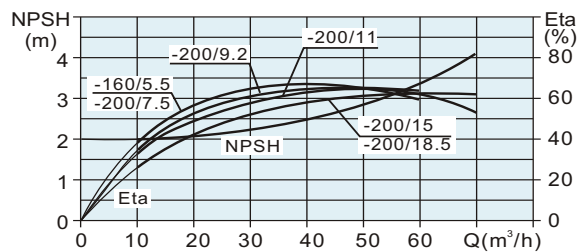
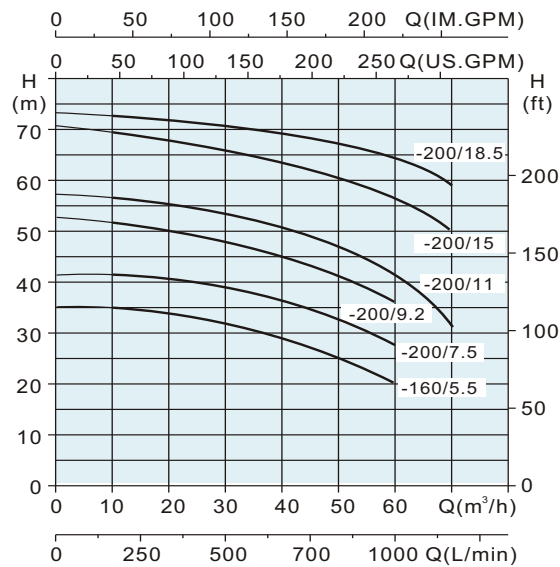

PUMP MODEL	P2		FLOW RATE (Q)												
			l/min	0	333	350	416	500	583	666	750	833	916	1000	
	m³/h	0	20	21	25	30	35	40	45	50	55	60			
WTX 50-160/5,5	5,5	7,5	H (m)	35	34	33,9	32,5	31,5	30	28,5	27	24,9			
WTX 50-200/7,5	7,5	10		42	40,5	40,4	40	39	37,5	36	34	32			
WTX 50-200/9,2	9,2	12,5		52	50	49,9	49	48,5	47	45	43	41			
WTX 50-200/11	11	15		58	55	54,8	54,4	53	52	51	48,5	47	35	31	
WTX 50-200/15	15	20		71	67,5	66,9	66,5	65,2	64,8	63,5	62	60	53	50	
WTX 50-200/18,5	18,5	25		73	71	70,8	70,5	70,1	69,9	69	68	67	62	59	

WTX

Complete Stainless Steel Monoblock Process Pumps

WTX 65

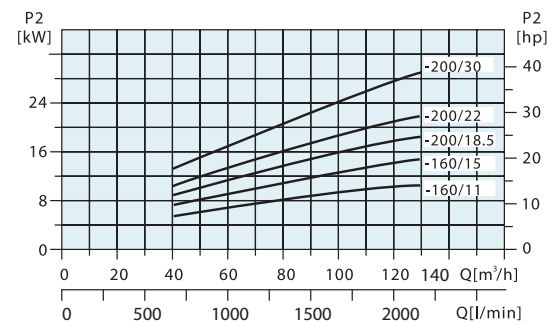
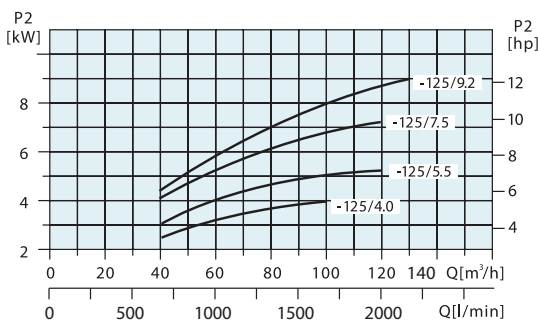
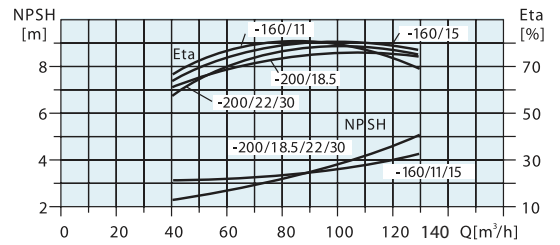
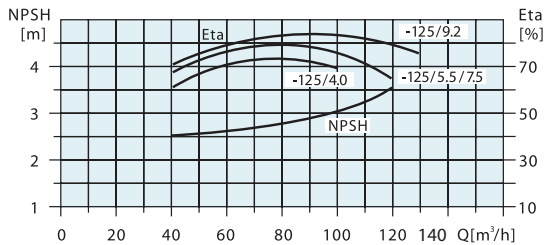
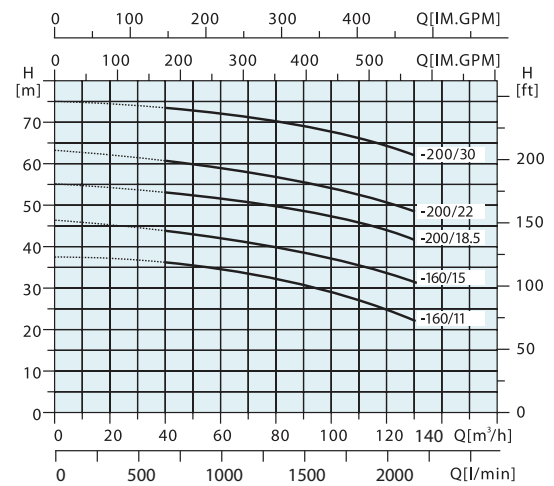
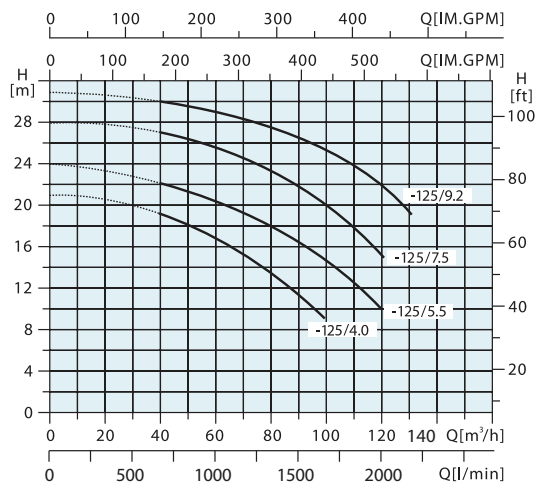

PUMP MODEL	P2		FLOW RATE (Q)													
			l/min	0	666	833	1000	1083	1166	1333	1416	1500	1666	1833	2000	2166
	m³/h	0	40	50	60	65	70	80	85	90	100	110	120	130		
WTX 65-125/4	4	5,5	H (m)	21	19	18	16,8	16	15	13	12	11	9			
WTX 65-125/5,5	5,5	7,5		24	22	21	20,3	19,5	19	18	17	16,1	14,8	12,7	10	
WTX 65-125/7,5	7,5	10		28	27	26	25,5	25	24,3	23	22,2	21,9	20	18	15	
WTX 65-125/9,2	9,2	12,5		31	30	29,4	29	28,4	28,1	27	26,5	26,1	25	23,5	22	19
WTX 65-160/11	11	15		37	36	35	34	33,4	33	32	31,5	31	29	27	25	22
WTX 65-160/15	15	20		46	44	43	42	41	40,3	39	38,5	38	37	35,8	33,5	32
WTX 65-200/18,5	18,5	25		55	53	52	51,4	51	50,3	49	48,5	48	47	45,3	44	41
WTX 65-200/22	22	30		63	60	59,6	58,2	57,5	57	56,5	55,8	55	54	53	50,5	49
WTX 65-200/30	30	40		75	73	72	71,5	71	70,1	69,5	69	68	67	66	64	63

WTX

Complete Stainless Steel Monoblock Process Pumps

WTX 80

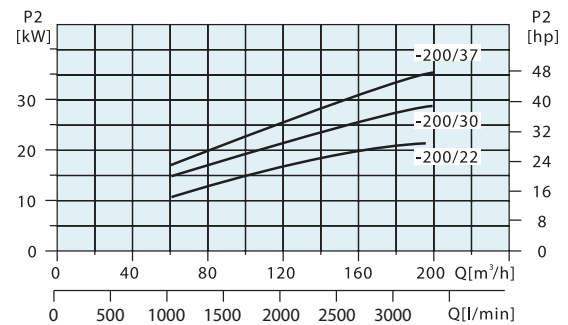
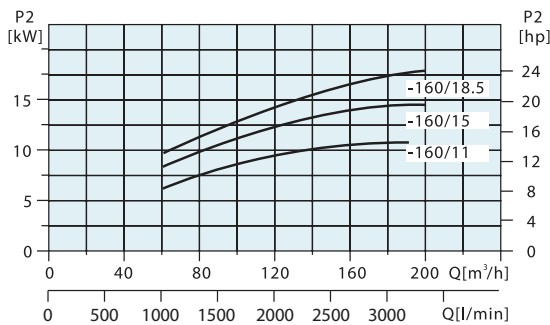
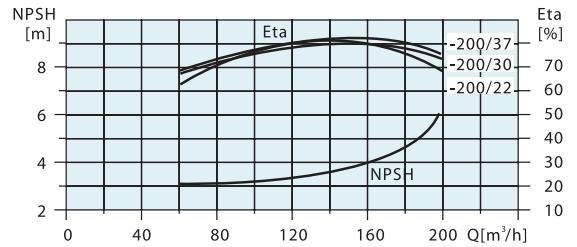
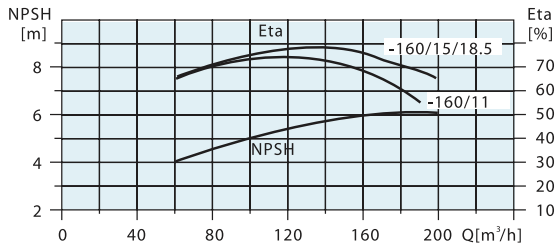
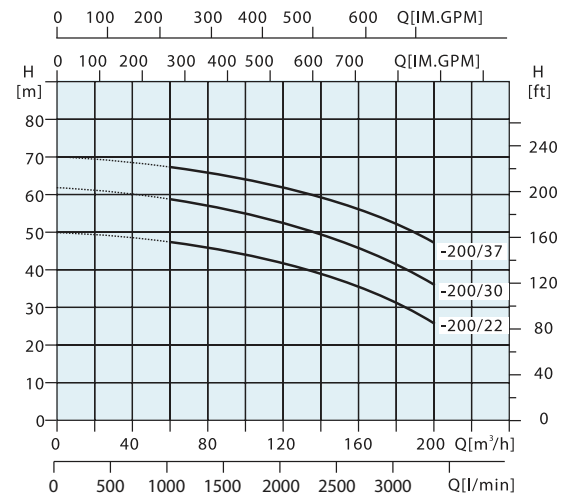
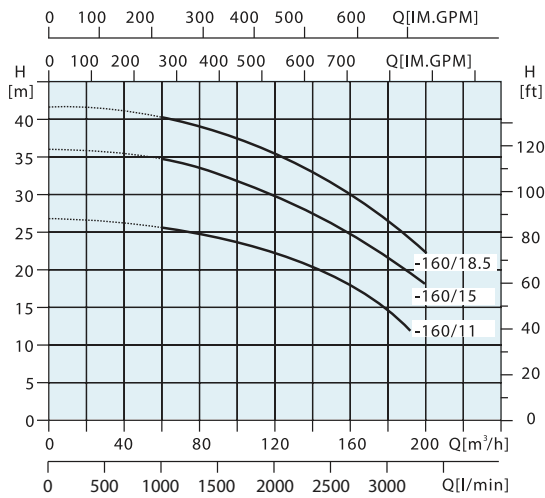

PUMP MODEL	P2		FLOW RATE (Q)																				
			l/min	0	1000	1083	1166	1333	1416	1500	1666	1833	2000	2166	2333	2500	2666	2833	3000	3200	3333		
	m³/h	0	60	65	70	80	85	90	100	110	120	130	140	150	160	170	180	192	200				
WTX 80-160/11	11	15	H (m)	27	26	25,5	25	24,5	24	23,5	23	22,5	22	21,4	20	18,5	17	16,6	14,5	11			
WTX 80-160/15	15	20		36	34,9	34,5	33,7	33	32,4	32	31	30,2	29	28,5	27	26	24	22,5	21,3	19	18		
WTX 80-160/18,5	18,5	25		42	39,5	39	38,8	38	37,5	37	36,5	36	35,1	33,7	33	31,2	30	27,5	26,5	23,5	22		
WTX 80-200/22	22	30		49	46	45,5	45	44,5	44	43,5	43	41	40,6	39,5	38	36,5	35	33	31	27	26		
WTX 80-200/30	30	40		61	57,5	57	56,5	56	55,5	55,3	55	53	52	50	49	47,5	46	43	41	37	36		
WTX 80-200/37	37	50		69	66	65,7	65,5	65	64,5	64	63	62,5	61	60	59	57,5	56	53	51,5	48,5	47		

WTX

Complete Stainless Steel Monoblock Process Pumps

Performance Tables and Dimensions

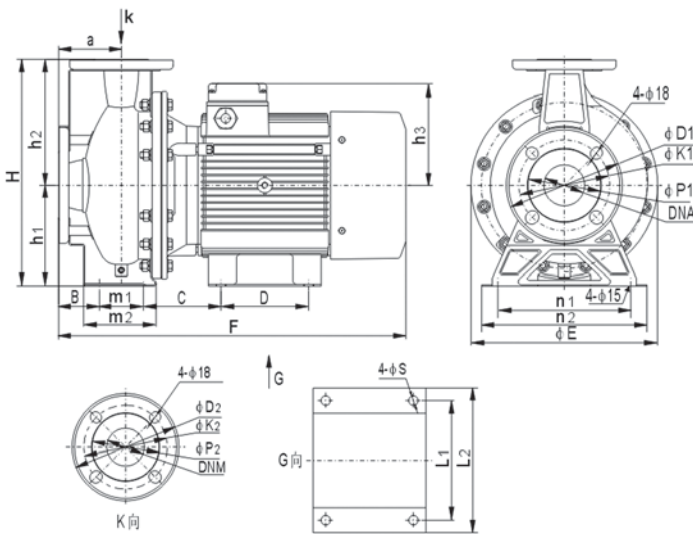

Part	Material
Pump Body	AISI 304/AISI 316
Impeller	AISI 304/AISI 316
Shaft	AISI 304/AISI 316
Mechanical Seal	SIC/SIC/EPDM

Model	P2 (kW)	φE	F	h	h1	h2	h3	a	m1	m2	n1	n2	B	C	D	φS	L1	L2	φD1	φk1	φP1	φD2	φK2	φP2	DNA	DNM
WTX 32-160	1,1	210	395	255	112	143	134	80	70	115	160	190	45	95	90	12	125	155	165	125	96	140	100	76	50	32
WTX 32-160	1,5	210	395	255	112	143	134	80	70	115	160	190	45	95	90	12	125	155	165	125	96	140	100	76	50	32
WTX 32-160	2,2	210	428	255	112	143	119	80	70	115	160	190	45	111	100	12	160	190	165	125	96	140	100	76	50	32
WTX 32-200	3,0	300	460	340	160	180	119	80	70	118	190	240	45	109	100	12	160	190	165	125	96	140	100	76	50	32
WTX 32-200	4,0	300	520	340	160	180	162	80	70	118	190	240	45	122	140	15	190	225	165	125	96	140	100	76	50	32
WTX 32-200	5,5	300	593	340	160	180	182	80	70	118	190	240	45	161	140	15	216	255	165	125	96	140	100	76	50	32
WTX 40-125	1,5	210	395	255	112	143	134	80	70	115	160	190	45	95	90	12	125	155	185	145	115	150	110	80	65	40
WTX 40-125	2,2	210	425	255	112	143	119	80	70	115	160	190	45	111	100	12	160	190	185	145	115	150	110	80	65	40
WTX 40-125	3,0	250	460	292	132	160	119	80	70	118	190	240	45	111	100	12	160	190	185	145	115	150	110	80	65	40
WTX 40-160	4,0	250	520	292	132	160	162	80	70	118	190	240	45	148	140	15	190	230	185	145	115	150	110	80	65	40
WTX 40-200	5,5	300	615	360	160	200	182	100	70	118	212	264	65	161	140	15	216	255	185	145	115	150	110	80	65	40
WTX 40-200	7,5	300	615	360	160	200	182	100	70	118	212	264	65	161	140	15	216	255	185	145	115	150	110	80	65	40
WTX40-200	11,0	350	671	360	160	200	255	100	70	118	212	264	65	147	210	15	254	320	185	145	115	150	110	80	65	40
WTX 50-125	3,0	250	455	292	132	160	119	80	70	115	190	240	45	110	100	12	160	190	185	145	115	165	125	96	65	50
WTX 50-125	4,0	250	520	292	132	160	162	80	70	115	190	240	45	148	140	15	190	230	185	145	115	165	125	96	65	50
WTX 50-160	5,5	300	615	360	160	200	182	100	70	118	212	264	65	161	140	15	216	255	185	145	115	165	125	96	65	50
WTX 50-200	7,5	300	615	360	160	200	182	100	70	118	212	264	65	161	140	15	216	255	185	145	115	165	125	96	65	50
WTX 50-200	9,2	300	617	360	160	200	182	100	70	118	212	264	65	161	140	15	216	255	185	145	115	165	125	96	65	50
WTX 50-200	11,0	350	671	360	160	200	255	100	70	118	212	264	65	147	210	15	254	320	185	145	115	165	125	96	65	50
WTX 50-200	15,0	350	671	360	160	200	255	100	70	118	212	264	65	147	210	15	254	320	185	145	115	165	125	96	65	50
WTX 50-200	18,5	350	715	360	160	200	255	100	70	118	212	264	65	147	254	15	254	320	185	145	115	165	125	96	65	50
WTX 65-125	4	256	514	340	160	180	162	100	95	152	212	250	53	105	140	15	190	230	200	160	132	185	145	115	80	65
WTX 65-125	5,5	256	530	340	160	180	162	100	95	152	212	250	53	113	140	15	190	230	200	160	132	185	145	115	80	65
WTX 65-125	7,5	256	568	340	160	180	162	100	95	152	212	250	53	113	140	15	190	230	200	160	132	185	145	115	80	65
WTX 65-125	9,2	256	636	340	160	180	179	100	95	152	212	250	53	175	140	15	216	255	200	160	132	185	145	115	80	65
WTX 65-160	11	300	620	360	160	200	179	100	95	152	212	250	53	152	140	15	216	255	200	160	132	185	145	115	80	65
WTX 65-160	15	300	662	292	160	200	179	100	95	152	212	250	53	152	140	15	216	255	200	160	132	185	145	115	80	65
WTX 65-200	18,5	300	748	405	180	225	255	100	95	148	250	290	5	456	-	15	254	320	200	160	132	185	145	115	80	65
WTX 65-200	22	300	776	405	180	225	275	100	95	148	250	290	53	169	241	15	279	355	200	160	132	185	145	115	80	65
WTX 65-200	30	300	844	405	180	225	308	100	95	148	250	290	53	177	305	18,5	318	386	200	160	132	185	145	115	80	65
WTX 80-160	11	256	669	405	180	225	179	125	95	176	250	290	78	183	140	15	216	255	220	180	152	200	160	132	100	80
WTX 80-160	15	256	711	405	180	225	179	125	95	176	250	290	78	183	140	15	216	255	220	180	152	200	160	132	100	80
WTX 80-200	18,5	256	769	405	180	225	255	125	95	176	250	290	78	452	-	15	254	320	220	180	152	200	160	132	100	80
WTX 80-200	22	300	811	430	180	250	275	125	95	176	280	320	78	180	241	15	279	355	220	180	152	200	160	132	100	80
WTX 80-200	30	300	880	450	200	250	308	125	95	176	280	320	78	188	305	18,5	318	386	220	180	152	200	160	132	100	80
WTX 80-200	37	300	880	450	200	250	308	125	95	176	280	320	78	188	305	18,5	318	386	220	180	152	200	160	132	100	80